

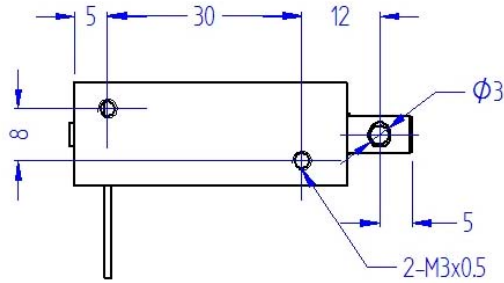

# D - Frame Solenoid

# SD0642

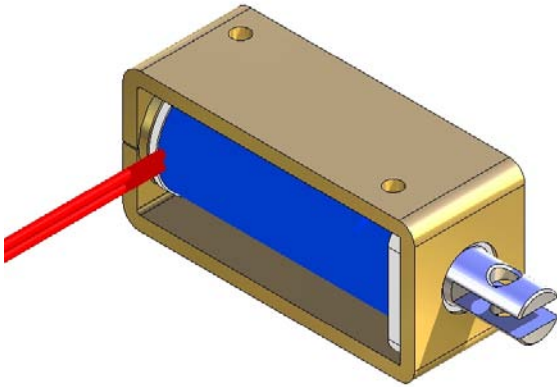

Dimensions in millimetres  
Total solenoid weight: 57g  
Plunger weight: 10g

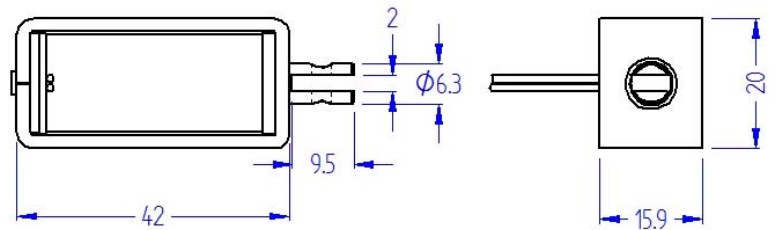

Force/Stroke Characteristics

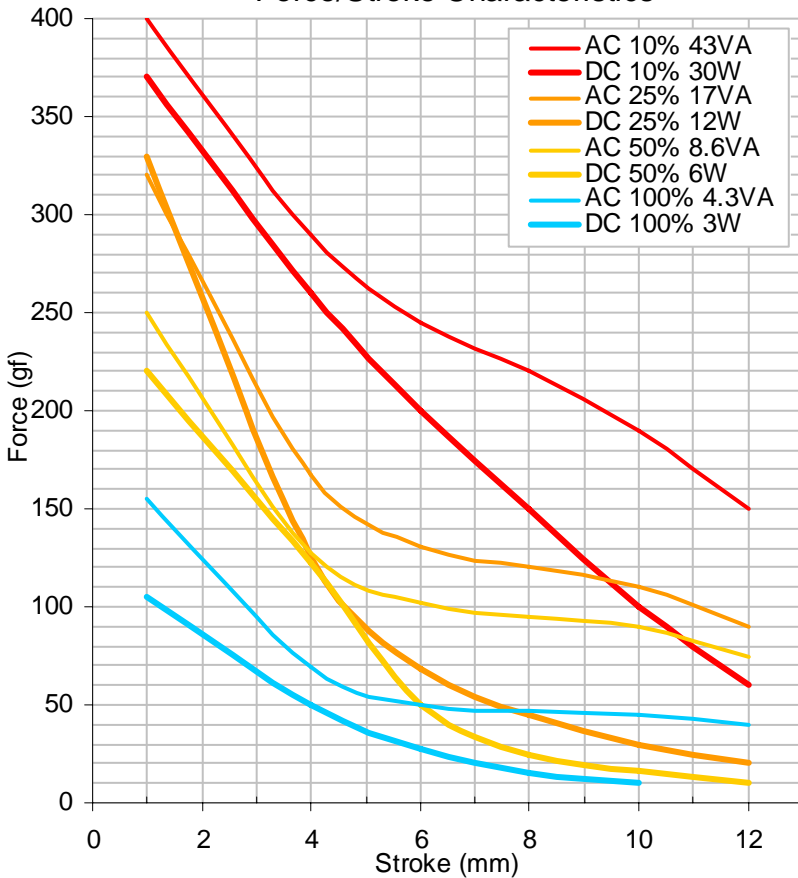

- Pull or thrust type
- Flying leads with optional terminals/connector
- Corrosion resistant plated parts
- Optional return spring
- Customised plunger ends and fixing centres
- Optional voltages and duty ratings

