

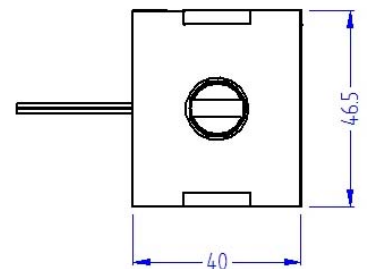

## D - Frame Solenoid

# SD1356

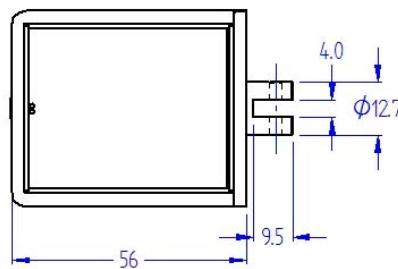
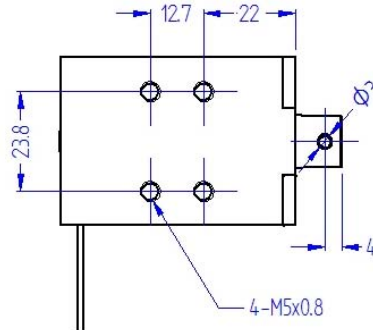
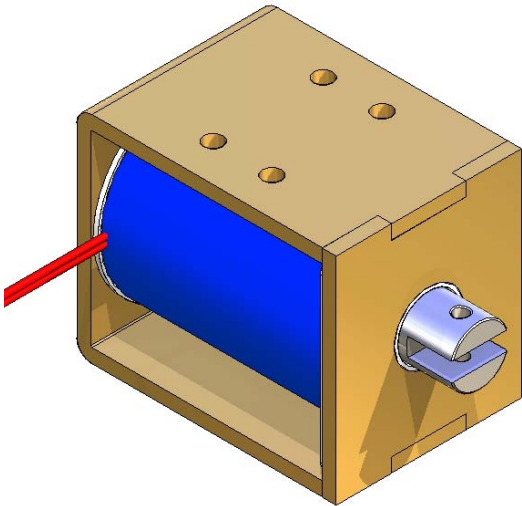

Dimensions in millimetres  
Total solenoid weight: 41g  
Plunger weight: 5g

### Force/Stroke Characteristics

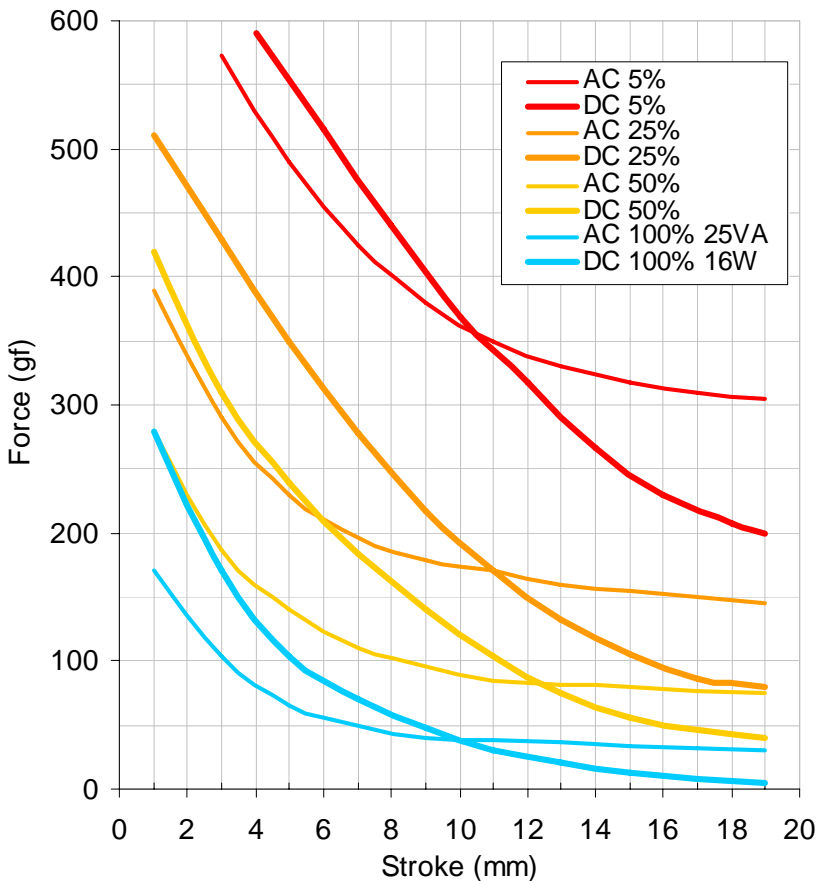

- Pull or thrust type
- Flying leads with optional terminals/connector
- Corrosion resistant plated parts
- Optional return spring
- Customised plunger ends and fixing centres
- Optional voltages and duty ratings

  
**SOLENTEC**  
SOLENOID TECHNOLOGY

Solentec Ltd, All Saints Industrial Estate, Shildon, County Durham, DL4 2RD, England  
Tel: +44 (0)1388 778555 Fax: +44 (0)1388 778999  
website: [www.solenoids.co.uk](http://www.solenoids.co.uk) e-mail: [enquiries@solenoids.co.uk](mailto:enquiries@solenoids.co.uk)